

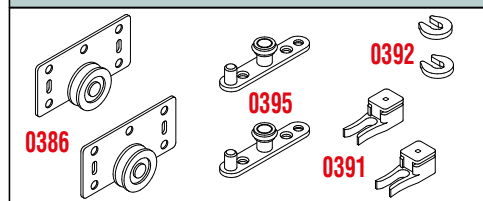



## KIT 0395-386 - MAX 50 KG



### Legenda KIT / Kit Legend

<b>0386</b>	Carrello inferiore con cuscinetto Ø30 <i>Lower truck with ball bearing Ø30</i>
<b>0395</b>	Guida superiore <i>Upper runner</i>
<b>0391</b>	Fermo superiore <i>Upper stopper</i>
<b>0392</b>	Antisganciamento per guida Art.0383 <i>Clasp for runner Art.0383</i>

### Legenda altri componenti Legend other items

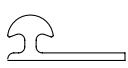
<b>0390</b>		Profilo alluminio superiore <i>Upper aluminium profile</i>
<b>0380</b>		Profilo alluminio inferiore <i>Lower aluminium profile</i>
<b>0300</b>		Profilo alluminio inferiore <i>Lower aluminium profile</i>

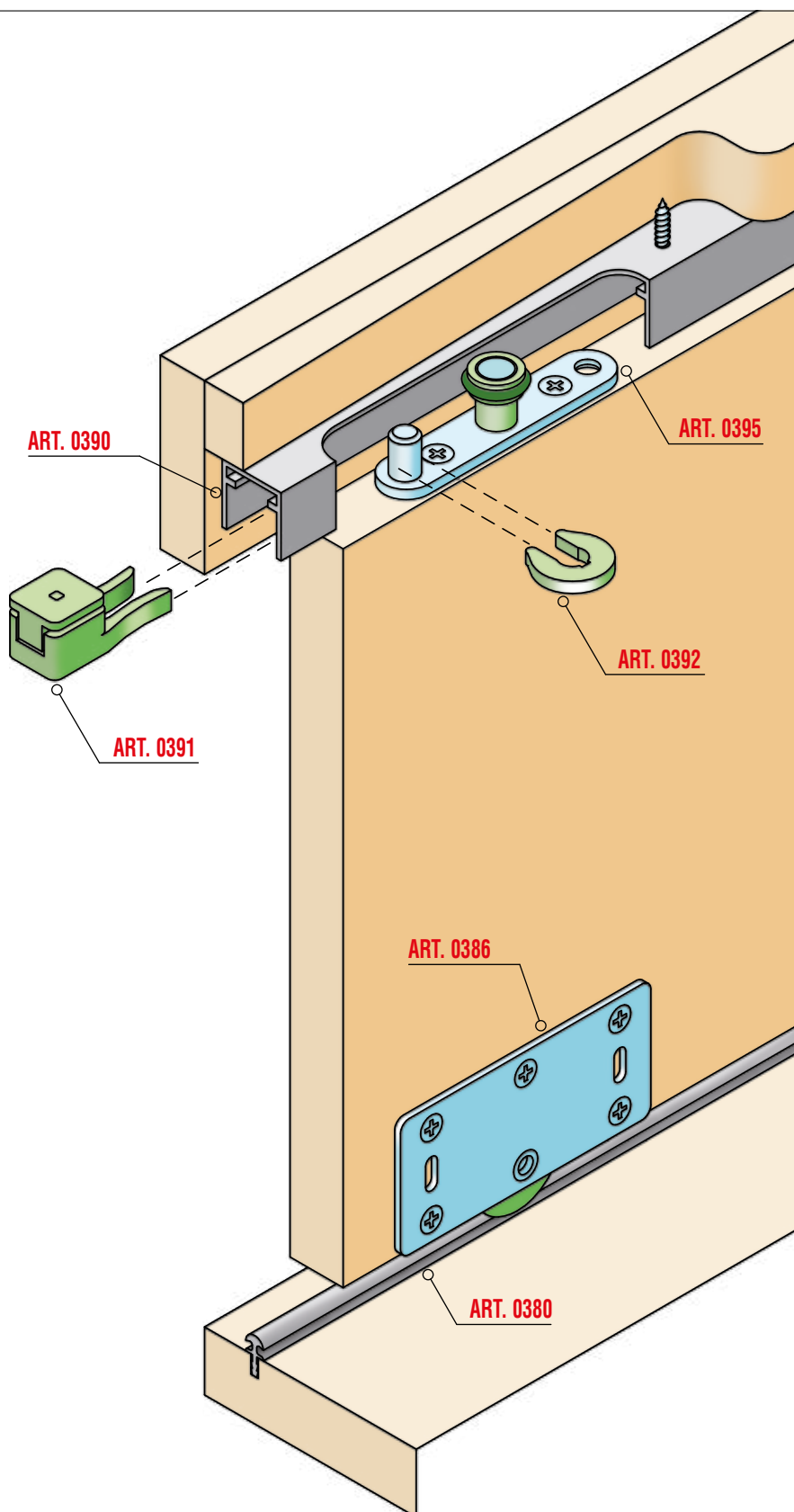



Sistemi scorrevoli per mobili / Sliding systems for furniture

**Sezione verticale / Vertical section**

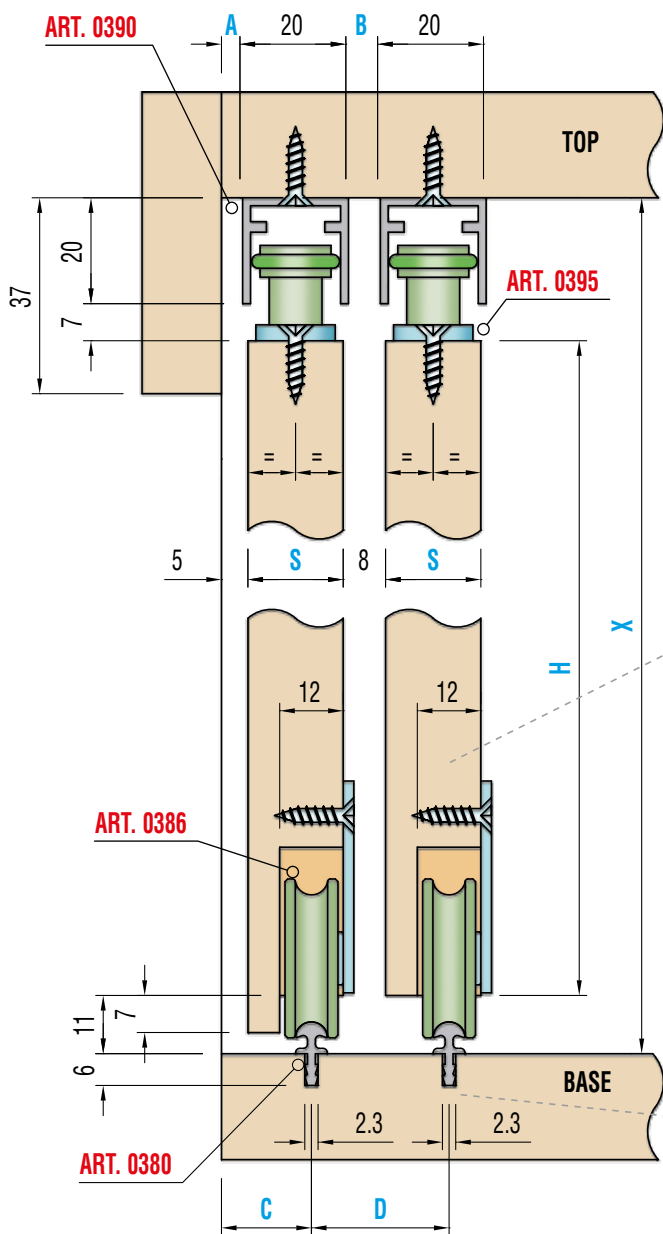

Peso massimo anta Kg. 50  
Maximum door weight Kg 50

<b>A</b> =	S* -14
<b>B</b> =	S* -12
<b>C</b> =	S* -1
<b>D</b> =	S* +8
<b>H</b> =	X -38

S\* (spessore / thickness)  
min.16

**Variante  
Special version**

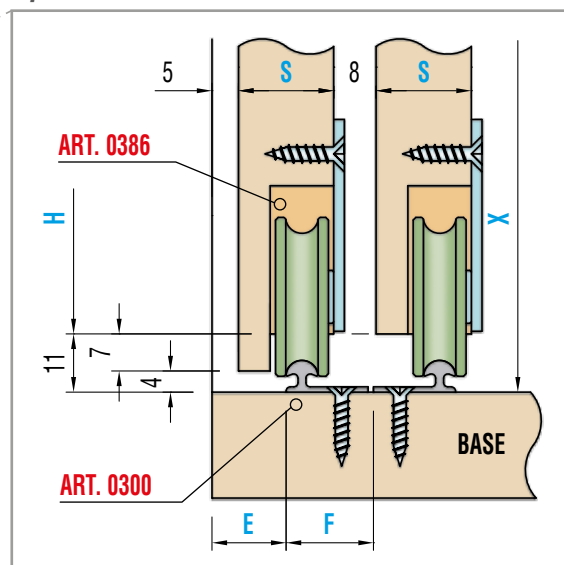

<b>E</b> =	S* -4
<b>F</b> =	S* -1,5
<b>H</b> =	X -38

**Schema Foratura ante / Doors drilling**

